

SAFEasy™ TYPE 2 LIGHT CURTAINS

SAFEasy™: safety in your hands

- **Integrated light curtain for HAND PROTECTION**
- **Maximum operating distance reaching 19 m**
- **Controlled heights ranging from 150 to 1800 mm**
- **New sturdy profile and rotating brackets**
- **Selectable Manual/Automatic Restart, EDM and Anti-Interference**

SG2-HAND SERIES

The new **SAFEasy™ SG2** light curtains represent the natural evolution of the SF2 series.

The new **SG2** series offers two models, **SG2-B “Base”** and **SG2-E “Extended”**, thus guaranteeing compatibility with the SF2 series (**SG2-B**), as well as offering advanced functions for a Type 2 safety light curtain, such as EDM and Anti-Interference (**SG2-E**). Models with controlled heights ranging from 150 to 1800 mm are available, all with an operating distance reaching 19 m. The response times ranging from 8 to 24 msec result to be amongst the lowest on the market, consenting the installation of the product nearer to the dangerous area.

As well as offering the base functions present in the **SG2-B** model, the **SG2-E** series integrates advanced functions for a Type 2 device such as manual/automatic Restart, EDM function, Anti-interference system (obtained thanks to the reduction to 9 m of the maximum operating distance). All selectable functions.

The new profile and rotating fixing brackets ease installation and the alignment of the emitting and receiving units, even at long distances and in applications with deviating mirrors.

The **SG2** series represents the ideal solution for all the typical applications of a Type 2 safety light curtain.



The characteristics introduced by the SG2 safety light curtains are:

- Operating distance reaching 19 m
- Wider controlled height range (reaching 1800 mm)
- Reduced response times, 25% less than SF2
- New sturdy and more functional profile
- Easier and quicker installation thanks to the new rotating fixing brackets that ease alignment even in the harshest conditions
- Compatibility with the entire SE accessory range
- SG2-E with selectable PLUS functions, such as Manual/Automatic Restart, EDM and Anti-Interference thanks to the reduction of the maximum operating distance from 19 to 9 m

DIMENSIONS

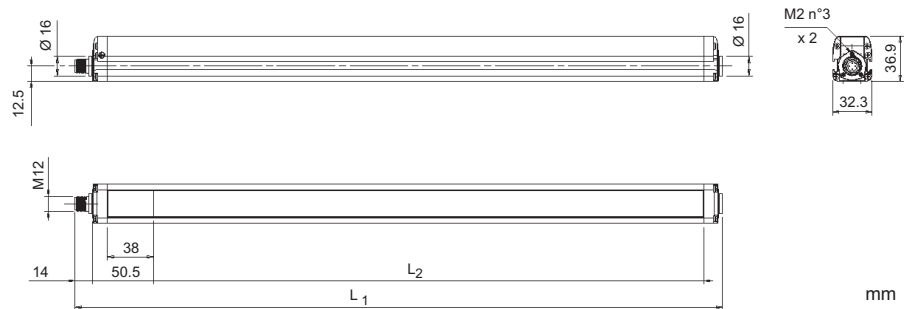

VERSIONS	L ₁	L ₂
SG2-30-015-00-*	233.3	153.3
SG2-30-030-00-*	383.2	303.2
SG2-30-045-00-*	533.2	453.3
SG2-30-060-00-*	683.2	603.2
SG2-30-075-00-*	833.2	753.3
SG2-30-090-00-*	983.2	903.2
SG2-30-105-00-*	1133.2	1053.2
SG2-30-120-00-*	1283.3	1203.3
SG2-30-135-00-*	1433.2	1353.2
SG2-30-150-00-*	1583.3	1503.3
SG2-30-165-00-*	1733.3	1653.3
SG2-30-180-00-*	1883.3	1803.3

* = X Base model or E-C Extended model

INDICATORS AND SETTINGS

SG2-B

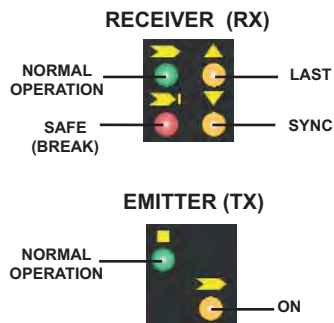

SG2-E

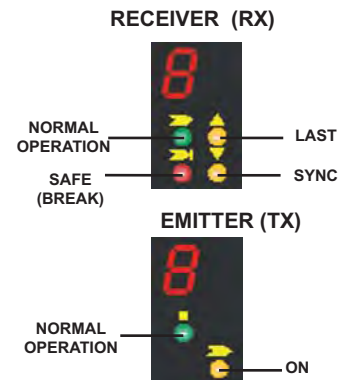

CONNECTIONS

SG2-B

M12 5-POLE CONNECTOR

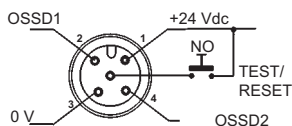

- 1 = brown = +24 Vdc
- 2 = white = OSSD1
- 3 = blue = 0 V
- 4 = black = OSSD2
- 5 = grey = TEST/RESET

M12 4-POLE CONNECTOR

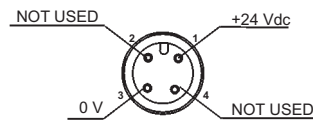

- 1 = brown = +24 Vdc
- 2 = white = NOT USED
- 3 = blue = 0 V
- 4 = black = NOT USED

SG2-E

M12 8-POLE CONNECTOR

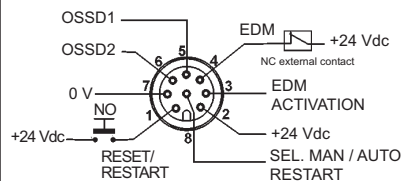

- 1 = white = RESET (*)
- 2 = brown = +24 Vdc
- 3 = green = EDM ACTIVATION
- 4 = yellow = EDM
- 5 = grey = OSSD1
- 6 = pink = OSSD2
- 7 = blue = 0 V
- 8 = red = SEL. MAN. / AUTO RESTART

M12 4-POLE CONNECTOR

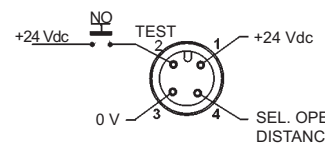

- 1 = brown = +24 Vcc
- 2 = white = TEST
- 3 = blue = 0 V
- 4 = black = SEL. OPERATING DISTANCE

TECHNICAL DATA

ELECTRICAL DATA

Power supply (Vdd):	24 Vdc \pm 20%
Consumption (emitter):	2 W max
Consumption (receiver):	3.5 W max (without load)
OSSD outputs:	2 PNP
Short-circuit protection:	1.4 A max
Output current:	0.5 A max on each output
Output voltage - ON status:	Vdd -1 V min
Output voltage - OFF status:	0.2 V max
Capacitive load:	2.2 μ F @ 24 Vdc max
Response time:	Refer to table
Controlled height:	150...1800 mm
Safety category:	Type 2
Auxiliary functions:	
SG2-B	Reset / Test Automatic Restart
SG2-E	Reset / Test Man./Auto Restart Selectable EDM Class I / Class III
Electrical protection:	
Connections:	
SG2-B	M12 4-pole for emitter M12 5-pole for receiver
SG2-E	M12 4-pole for emitter M12 8-pole for receiver
Cable length (for powering):	50 m max *

OPTICAL DATA

Light emission:	Infrared LED (950 nm)
Resolution:	30 mm
Operating distance:	0.2...19 m (SG2-B) selectable 0.2...9 m / 0.2...19 m (SG2-E)
Aperture angle (EAA) :	\pm 5°
Ambient light rejection:	IEC-61496-2

MECHANICAL AND ENVIRONMENTAL DATA

Operating temperature:	0... + 55 °C
Storage temperature:	- 25... + 70 °C
Temperature class:	T6
Humidity:	15...95 % (non condensating)
Mechanical protection:	IP 65 (EN 60529)
Vibrations:	0.35 mm amplitude 10 ... 55 Hz frequency, 20 sweep per axis 1 octave/min (EN 60068-2-6)
Shock resistance:	16 ms (10 G) 1.000 shock per axis (EN 60068-2-29)
Housing material:	Painted aluminium (yellow RAL 1003)
Protective shield materiale:	PMMA
Cap material:	PC MAKROLON
Weight:	1 kg / m

* If a longer cable has to be used, please verify that the capacitive load specifications are respected

TABLES

Model

SG2 height 150	8
SG2 height 300	16
SG2 height 450	24
SG2 height 600	32
SG2 height 750	40
SG2 height 900	48
SG2 height 1050	56
SG2 height 1200	64
SG2 height 1350	72
SG2 height 1500	80
SG2 height 1650	88
SG2 height 1800	96

Table 1: NUMBER OF CONTROLLED BEAMS

Model

SG2 height 150	150
SG2 height 300	300
SG2 height 450	450
SG2 height 600	600
SG2 height 750	750
SG2 height 900	900
SG2 height 1050	1050
SG2 height 1200	1200
SG2 height 1350	1350
SG2 height 1500	1500
SG2 height 1650	1650
SG2 height 1800	1800

Table 2: CONTROLLED HEIGHT (mm)

Model

SG2 height 150	8
SG2 height 300	9
SG2 height 450	11
SG2 height 600	12
SG2 height 750	14
SG2 height 900	15
SG2 height 1050	17
SG2 height 1200	18
SG2 height 1350	20
SG2 height 1500	21
SG2 height 1650	23
SG2 height 1800	24

Table 3: RESPONSE TIME (ms)



NEW FEATURES INTRODUCED

The **SG2** safety light curtains present some new important features:

■ Increased operating distance

The 19 m operating distance makes the **SG2** safety light curtain the ideal device for plants with large dimensions, as well as guaranteeing improved flexibility in applications with deviating mirrors.

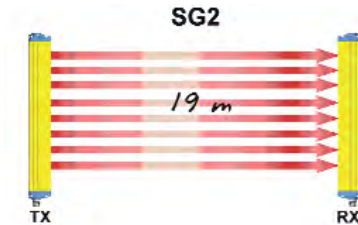

■ Controlled height range extended from 150 to 1800 mm

The controlled height extended to 1800 mm allows SG2 to be used in applications where high areas have to be protected.

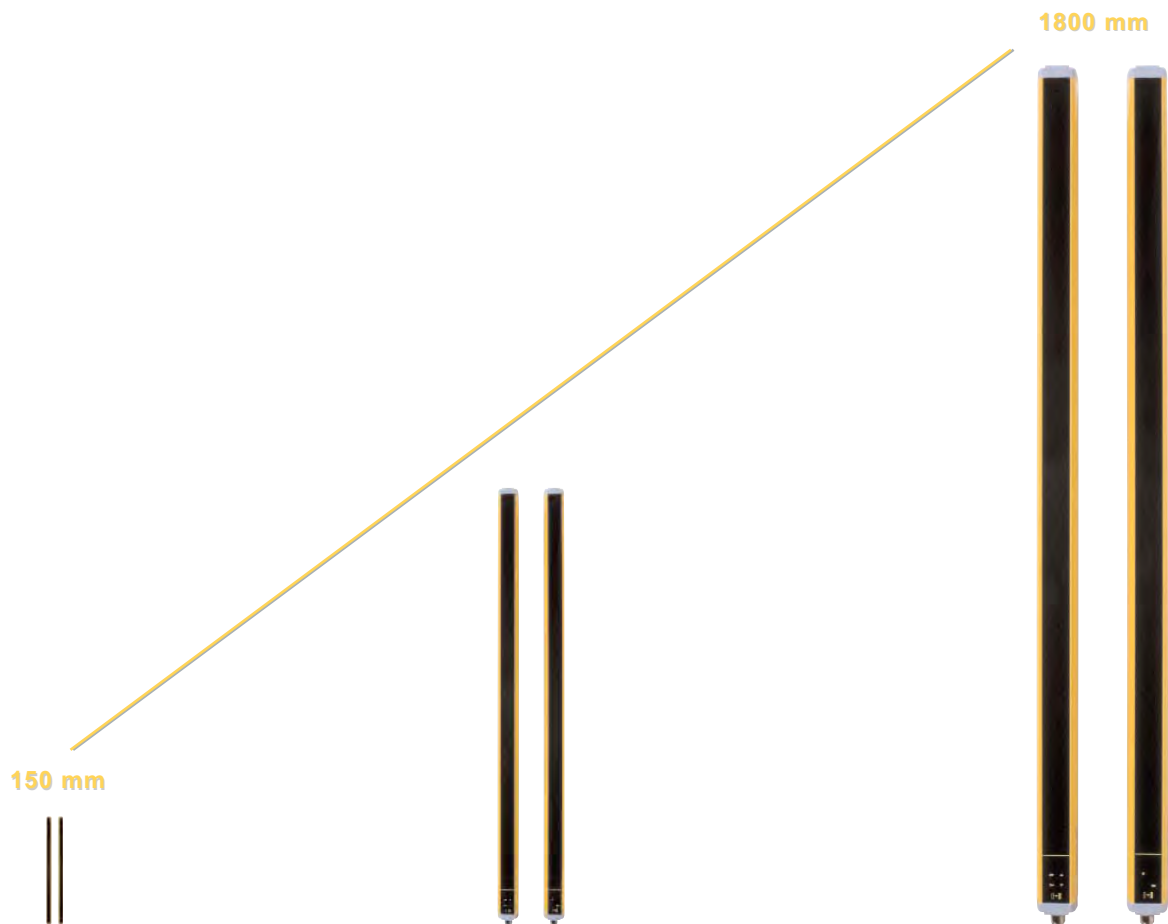

■ Response time reduction

The SG2 light curtain can be installed even closer to the dangerous area thanks to improved response times, thus reducing the machine dimensions and consequently the plant costs. Moreover, SG2, as are as the response times are concerned, can be interchanged with the corresponding products of the major manufacturers.



SG2-E: PLUS FUNCTIONS

EDM

The EDM function allows to connect the light barrier to a couple of simple forced-guided safety relays instead to a Type 2 safety relay and thus guaranteeing an enormous economical advantage.

Connection with EDM function

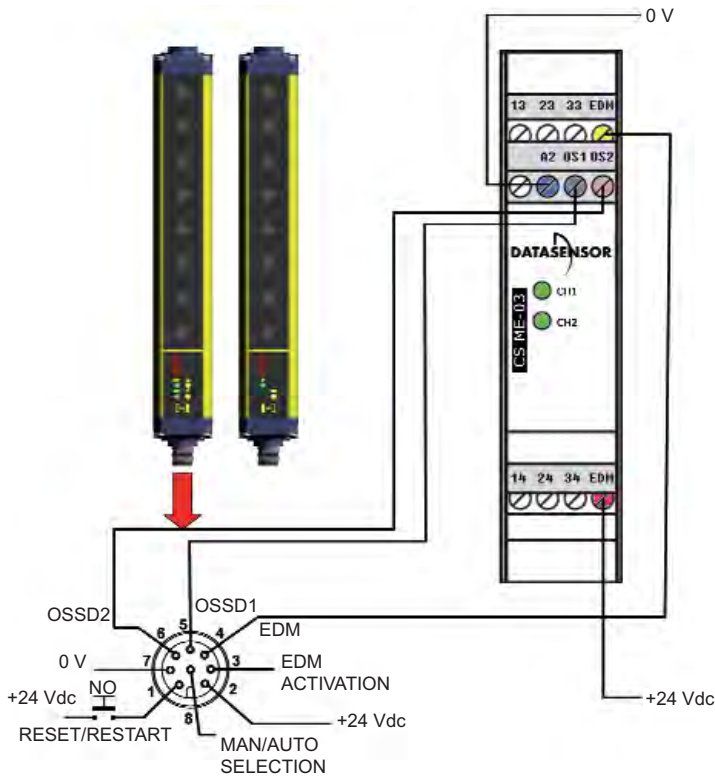

Connection without EDM function

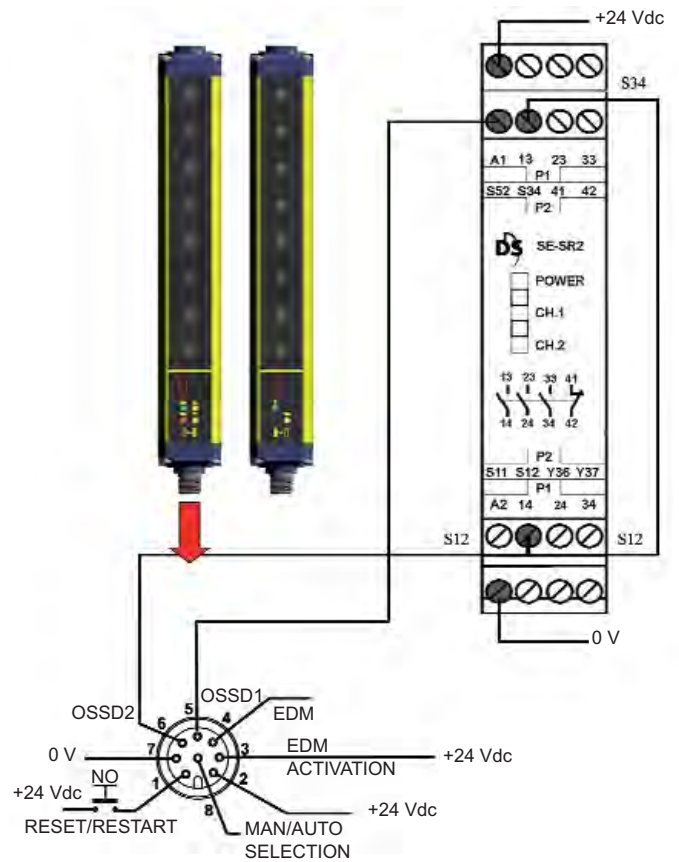

Anti-Interference system

The Anti-Interference system consists of the installation of different light curtains aligned one next to the other avoiding mutual optical interference, without the need to install separating shields.

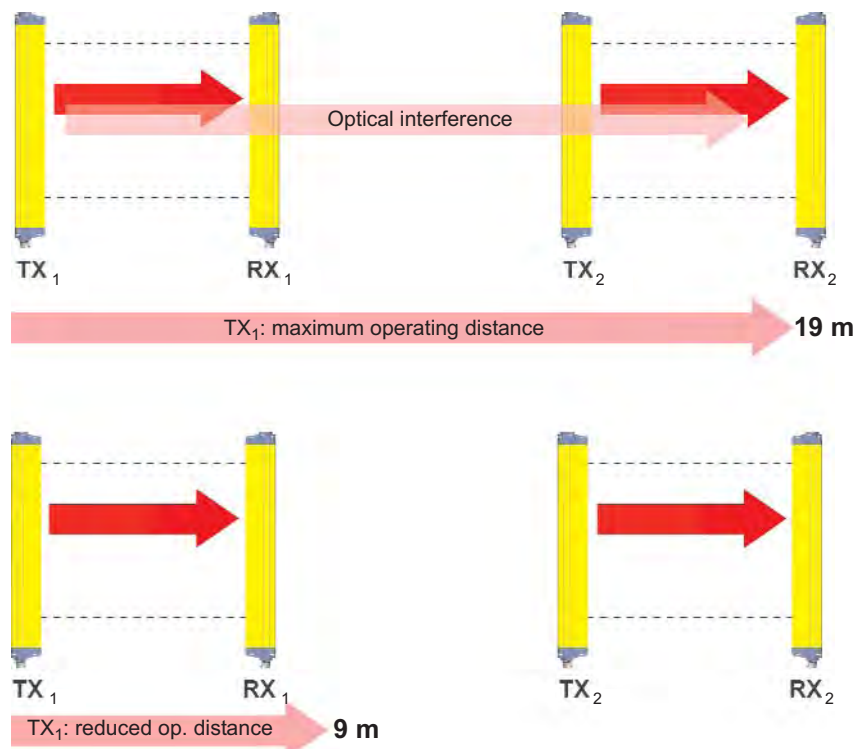

APPLICATIONS

The SG2 safety light curtains provide solutions in all automation fields where the access to dangerous areas has to be controlled.

In particular, the safety curtains can be used in stopping moving parts in:

- Automatic machines;
- Packaging, material handling and storage machines;
- Textile, wood-working and ceramic machines;
- Automatic and semi-automatic assembling lines;
- Automatic warehouses.

Example 1: Hand protection on forming machine

The aim is to prevent the squashing of operator hands during stacking operations. The solution must not interfere with the production process.

Solution: the IP69K protection is obtained through an acrylic PMMA tube and offers an effective protection without trapping dirt or contamination. The cap prevents water or dirt from entering the tube and at the same time, prevents also internal condensation. The cable connection is protected and fixed by a PG gland that prevents water or dirt from entering the tube.

Advantages: the profile dimension and rotating fixing bracket resolve typical applications that require fixing in reduced space, guaranteeing maximum installation flexibility and adaption to the machine dimensions.

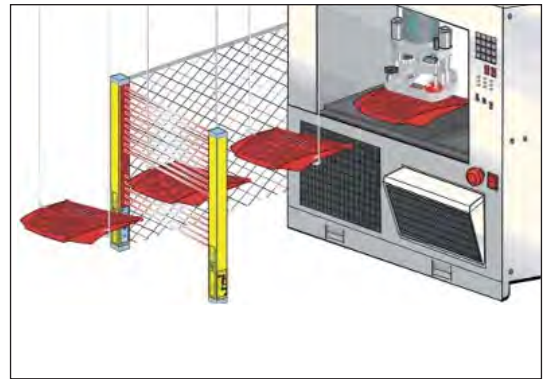

Example 2: Cooling and air-conditioning systems

Cooling and air-conditioning systems as well as devices and components for auto vehicles are controlled inside a machine to check leaks, using a helium-based spectrometer. The point where the components are positioned in the measurement room has to be protected in full compliance with Type 2 requirements, guaranteeing space reduction and the safe access to a protected area.

Solution: the SG2 light curtain represents the best solution considering the safety requirements and the application. The test machine is immediately stopped even when only one of the beams is interrupted.

Advantages: the SG2 light curtain satisfies the customer needs in terms of access simplicity in presence of a machine stop. Easy installation, configuration and use are other advantages.

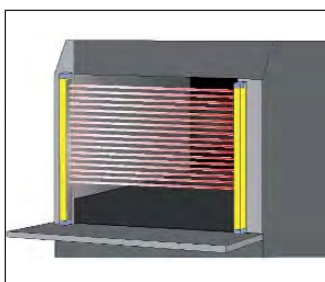
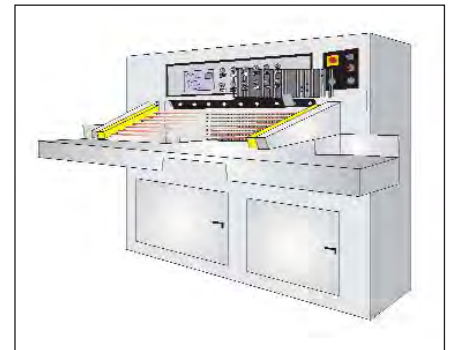

Example 3: Automatic warehouses

The SG2 Type 2 light curtain represents the ideal solution to protect the operator from hand squashing, abrasion and loss, or parts of it due to the moving parts.

Solution: the SG2 light curtain represent the best solution considering the safety requirements and the application. The carousel is immediately stopped even when only one of the beams is interrupted.

Advantages: the profile and fixing systems ease and speed up installation. The excellent performances (operating distance, controlled heights and response times) guarantee maximum plant flexibility.

FIXING BRACKETS

Rotating fixing bracket¹

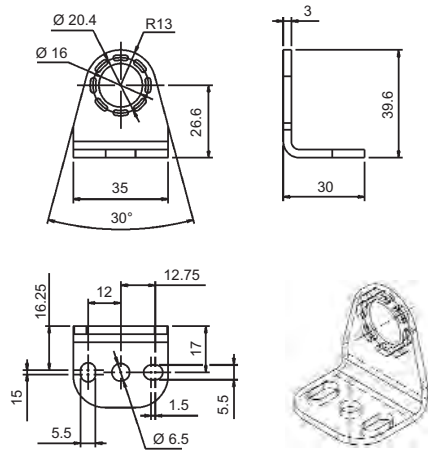

Angled fixing bracket²

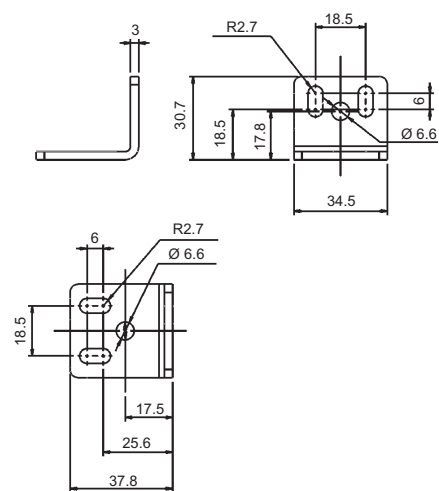

¹ Supplied with the Extended model

² Supplied with the Base model

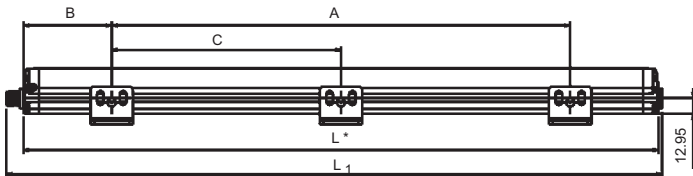
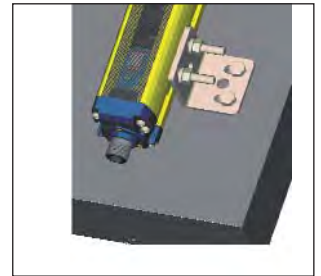
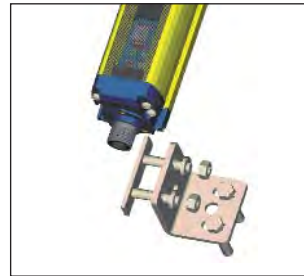

MODELS	L (mm)	A (mm)	B (mm)	C (mm)
SG2-30-015-OO-*	216.3	108	54	-
SG2-30-030-OO-*	366.2	216	75	-
SG2-30-045-OO-*	516.3	316	100	-
SG2-30-060-OO-*	666.2	366	150	-
SG2-30-075-OO-*	816.3	466	175	-
SG2-30-090-OO-*	966.2	566	200	-
SG2-30-105-OO-*	1116.2	666	225	-
SG2-30-120-OO-*	1266.3	966	150	483
SG2-30-135-OO-*	1416.2	1066	175	533
SG2-30-150-OO-*	1566.3	1166	200	583
SG2-30-165-OO-*	1716.3	1266	225	633
SG2-30-180-OO-*	1866.3	1366	250	683

* = X Base model or E-C Extended model

Installation with anti-vibration supports

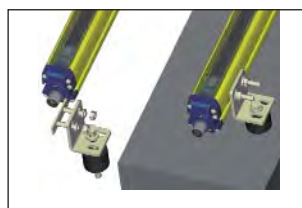
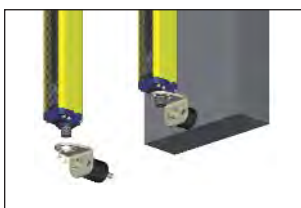

MODEL SELECTION AND ORDER INFORMATION

MODEL	DESCRIPTIONE	ORDER N°
SG2-B		
SG2-30-015-OO-X	Type 2 safety light curtain h=150 mm	957801000
SG2-30-030-OO-X	Type 2 safety light curtain h=300 mm	957801010
SG2-30-045-OO-X	Type 2 safety light curtain h=450 mm	957801020
SG2-30-060-OO-X	Type 2 safety light curtain h=600 mm	957801030
SG2-30-075-OO-X	Type 2 safety light curtain h=750 mm	957801040
SG2-30-090-OO-X	Type 2 safety light curtain h=900 mm	957801050
SG2-30-105-OO-X	Type 2 safety light curtain h=1050 mm	957801060
SG2-30-120-OO-X	Type 2 safety light curtain h=1200 mm	957801070
SG2-30-135-OO-X	Type 2 safety light curtain h=1350 mm	957801080
SG2-30-150-OO-X	Type 2 safety light curtain h=1500 mm	957801090
SG2-30-165-OO-X	Type 2 safety light curtain h=1650 mm	957801100
SG2-30-180-OO-X	Type 2 safety light curtain h=1800 mm	957801110
SG2-E		
SG2-30-015-OO-E-C	Type 2 safety light curtain h=150 mm	957801340
SG2-30-030-OO-E-C	Type 2 safety light curtain h=300 mm	957801350
SG2-30-045-OO-E-C	Type 2 safety light curtain h=450 mm	957801360
SG2-30-060-OO-E-C	Type 2 safety light curtain h=600 mm	957801370
SG2-30-075-OO-E-C	Type 2 safety light curtain h=750 mm	957801380
SG2-30-090-OO-E-C	Type 2 safety light curtain h=900 mm	957801390
SG2-30-105-OO-E-C	Type 2 safety light curtain h=1050 mm	957801400
SG2-30-120-OO-E-C	Type 2 safety light curtain h=1200 mm	957801410
SG2-30-135-OO-E-C	Type 2 safety light curtain h=1350 mm	957801420
SG2-30-150-OO-E-C	Type 2 safety light curtain h=1500 mm	957801430
SG2-30-165-OO-E-C	Type 2 safety light curtain h=1650 mm	957801440
SG2-30-180-OO-E-C	Type 2 safety light curtain h=1800 mm	957801450

ACCESSORY SELECTION AND ORDER INFORMATION

MODEL	DESCRIPTION	ORDER N°
CS-A1-02-U-03	M12 4-pole unshielded axial 3 m connector, UL 2464	95ASE1120
CS-A1-02-U-05	M12 4-pole unshielded axial 5 m connector, UL 2464	95ASE1130
CS-A1-02-U-10	M12 4-pole unshielded axial 10 m connector, UL 2464	95ASE1140
CS-A1-02-U-15	M12 4-pole unshielded axial 15 m connector, UL 2464	95ASE1150
CS-A1-02-U-25	M12 4-pole unshielded axial 25 m connector, UL 2464	95ASE1160
CS-A1-03-U-03	M12 5-pole unshielded axial 3 m connector, UL 2464	95ASE1170
CS-A1-03-U-05	M12 5-pole unshielded axial 5 m connector, UL 2464	95ASE1180
CS-A1-03-U-10	M12 5-pole unshielded axial 10 m connector, UL 2464	95ASE1190
CS-A1-03-U-15	M12 5-pole unshielded axial 15 m connector, UL 2464	95ASE1200
CS-A1-03-U-25	M12 5-pole unshielded axial 25 m connector, UL 2464	95ASE1210
CS-A1-06-U-03	M12 8-pole unshielded axial 3 m connector, UL 2464	95ASE1220
CS-A1-06-U-05	M12 8-pole unshielded axial 5 m connector, UL 2464	95ASE1230
CS-A1-06-U-10	M12 8-pole unshielded axial 10 m connector, UL 2464	95ASE1240
CS-A1-06-U-15	M12 8-pole unshielded axial 15 m connector, UL 2464	95ASE1250
CS-A1-06-U-25	M12 8-pole unshielded axial 25 m connector, UL 2464	95ASE1260
ST-KSTD	Angled fixing brackets (4 pc kit)	95ACC1670
ST-K4AV	Anti-vibration supports (4 pc kit)	95ACC1700
ST-K6AV	Anti-vibration supports (6 pc kit)	95ACC1710
ST-K4ROT	Top-Bottom rotating fixing brackets (4 pc kit)	95ASE1280

Please refer also to **Safety Device Accessories**



Distributed by:



Datasensor SpA endeavours to continuously improve and renew its products; for this reason the technical data and contents of this catalogue may undergo variations without prior notice. For correct installation and use Datasensor SpA can guarantee only the data indicated in the instruction manual supplied with the products.

SAFETY DEVICES

Printed in Italy in November 2008
Rev. 03