

**SAFEasy™ TYPE 4 LIGHT CURTAINS**

- **Integrated light curtains for BODY PROTECTION**
- **'T' shaped, 'L' shaped and linear versions with 2 and 3 beams**
- **Pre-assembled, pre-wired and pre-aligned Muting sensors**
- **Integrated Muting lamp**

## SE4T-L MUTING SERIES

The **SAFEasy™** light curtains, conforming with the IEC 61496-1 and IEC 61496-2 standards, are Type 4 safety devices according to EN 954-1 and are particularly suitable for body protection of operators exposed to risk.

The safety light curtains of the **SE4T-L MUTING** series satisfy all applications that require the Muting function, thanks to the use of pre-assembled, pre-cabled and pre-aligned Muting sensors. Models with 'T' integrated Muting sensors for two-way Muting, 'L' integrated Muting sensors for one-way Muting and linear versions without integrated Muting sensors are available.

Models with 2 and 3 safety beams with 500 and 800 mm detection heights offer 3 m operating distance for 'T' and 'L' shaped versions, or 25 m operating distance for linear versions.

Specific dip-switches, that can be reached through a slot present on the front of the receiver unit, protected by a lid and opened with a simple screwdriver, guarantee rapid and safe device setting.

The user can configure the manual or automatic Restart, L or T Muting mode, a 10' or infinite Muting time-out as well as the EDM function.

All models are equipped with a luminous Muting signalling lamp built-in on the top of the receiving unit.

The compact dimensions (35 x 40 mm), patent-covered, easy installation and excellent performances make the **SAFEasy™** light curtains particularly suitable for applications that require material passage through a dangerous area, as for example in palletisers / depalletisers.



# SAFEASY™ TYPE 4 LIGHT CURTAINS

The main features of the safety light curtains of the SE4T-L MUTING series are given below:

- possibility of vertically adjusting the horizontal arms along the device slot, with an angular regulation of  $\pm 8^\circ$ ;
- use of polarised retroreflex Muting sensors with red emission;
- device configuration through dip-switches positioned on the receiver front side for selection of manual or automatic Restart, the number of Muting sensors, 10 minute or infinite Muting time-out and EDM function;
- simple connection thanks to two M12 8 and 5 pole connectors for the receiver and M12 4-pole connector for the emitter;
- SE-SRT connection box, for on board installation, is available as an accessory, with integrated safety relays for the Reset, Restart, and Override.

## DIMENSIONS

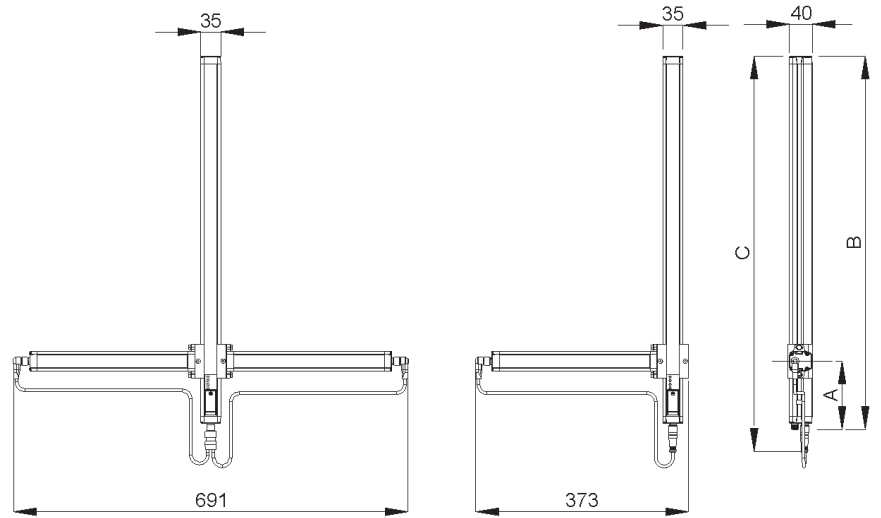

mm

## Patented easy installation



## Built-in Muting lamp



MODEL	A	B	C
SE4-T2-050-PP-W	120...260	653	690
SE4-T3-080-PP-W	120...260	953	990
SE4-L2-050-PP-W	120...260	653	690
SE4-L3-080-PP-W	120...260	953	990
SE4-S2-050-PP-W	-	653	690
SE4-S3-080-PP-W	-	953	990

## CONNECTIONS

### RECEIVER (RX)

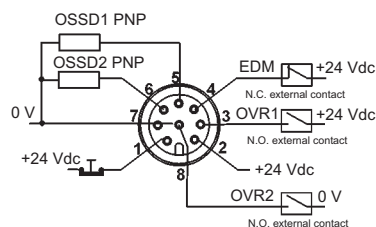

- 1 = white = TEST/START
- 2 = brown = +24 Vdc
- 3 = green = OVERRIDE 1
- 4 = yellow = EDM
- 5 = grey = OSSD1
- 6 = pink = OSSD2
- 7 = blue = 0 V
- 8 = red = OVERRIDE 2

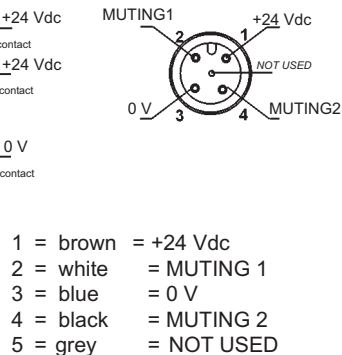

- 1 = brown = +24 Vdc
- 2 = white = MUTING 1
- 3 = blue = 0 V
- 4 = black = MUTING 2
- 5 = grey = NOT USED

### EMITTER (TX)

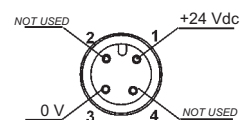

- 1 = brown = +24 Vdc
- 2 = white = NOT USED
- 3 = blue = 0 V
- 4 = black = NOT USED

## TECHNICAL DATA

<b>Power supply:</b>	24 Vdc ± 20% (SELV / PELV)
<b>Consumption:</b>	30 mA max. / 0,9 W (emitter) 75 mA max. / 2,2 W (receiver without load) 35 mA max. / 1 W (horizontal arm with sensors OFF)
<b>Light emission:</b>	infrared LED 880 nm
<b>Optic diameter:</b>	Ø 16 mm
<b>Number of controlled beams:</b>	refer to table
<b>Optic interaxis:</b>	refer to table
<b>Resolution:</b>	refer to table
<b>1st beam installation height:</b>	refer to table
<b>Through beam operating distance:</b>	0.5 ... 3 m (SE4-T/SE4-L vers.) 0.5 ... 25 m (SE4-S vers.)
<b>Receiver indicators:</b>	green / red SAFE / BREAK LED 2 yellow ALIGNMENT LEDs green POWER ON LED built-in yellow MUTING LAMP
<b>Emitter indicators:</b>	yellow blinking FAILURE LED green POWER ON LED
<b>Output type:</b>	2 PNP
<b>Output current:</b>	0.5 A max. each output, short-circuit protection
<b>Response time:</b>	14 ms
<b>Selectable functions:</b>	refer to table
<b>Muting signal activation timing:</b>	max. 4 sec.
<b>Time-out period:</b>	Muting: 10 minutes / infinite Override: 2 minutes
<b>Receiver connection:</b>	M12 5-pole / 8-pole connector
<b>Emitter connection:</b>	M12 4-pole connector
<b>Cable length:</b>	50 m max (with 50 nF capacitive load)
<b>Safety category:</b>	Type 4
<b>Electrical protection:</b>	class 1
<b>Mechanical protection:</b>	IP65
<b>Housing material:</b>	aluminium with PC Makrolon plastic caps
<b>Weight:</b>	3.8 Kg max. (T vers.) 2.9 Kg max. (L vers.) 2 Kg max. (Linear vers.)
<b>Operating temperature:</b>	-10 ... +55 °C
<b>Storage temperature:</b>	-25 ... +70 °C
<b>Reference standards:</b>	EN 954-1, IEC 61496-1, IEC 61496-2



## SELECTION TABLE

<b>SE4-T2-050-PP-W</b>	
order n°:	957201751
beam n°:	2
optic interaxis:	500 mm
resolution:	515 mm
1st beam installation height:	400 mm
<b>SE4-T3-080-PP-W</b>	
order n°:	957201761
beam n°:	3
optic interaxis:	400 mm
resolution:	415 mm
1st beam installation height:	300 mm
<b>SE4-L2-050-PP-W</b>	
order n°:	957201771
beam n°:	2
optic interaxis:	500 mm
resolution:	515 mm
1st beam installation height:	400 mm
<b>SE4-L3-080-PP-W</b>	
order n°:	957201781
beam n°:	3
optic interaxis:	400 mm
resolution:	415 mm
1st beam installation height:	300 mm
<b>SE4-S2-050-PP-W</b>	
order n°:	957201791
beam n°:	2
optic interaxis:	500 mm
resolution:	515 mm
1st beam installation height:	400 mm
<b>SE4-S3-080-PP-W</b>	
order n°:	957201801
beam n°:	3
optic interaxis:	400 mm
resolution:	415 mm
1st beam installation height:	300 mm



### DIP-SWITCHES

- 1 - 10 min. (ON) / infinite (OFF) Muting time-out
- 2 - 'T' mode (ON) / 'L' mode (OFF)
- 3 - EDM inactive (ON) / EDM active (OFF)
- 4 - Automatic (ON) / manual (OFF) Restart

## FUNCTIONING MODE

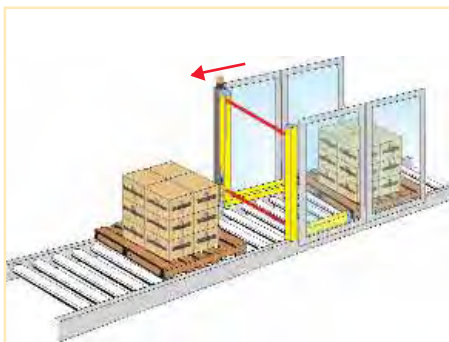

Version with 'L' integrated Muting sensors for unidirectional Muting

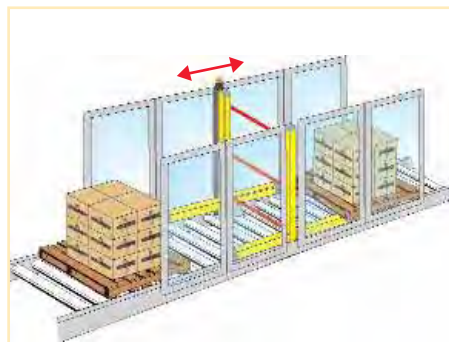

Version with 'T' integrated Muting sensors for bidirectional Muting

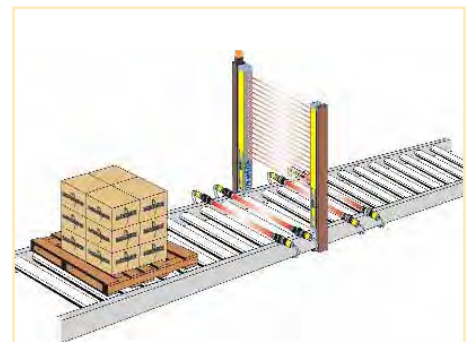

Linear version with external Muting sensors

## MODEL SELECTION AND ORDER INFORMATION

MODEL	DESCRIPTION	ORDER N°
SE4-T2-050-PP-W	Type 4 'T' shaped safety light curtain with 2 beams	957201751
SE4-T3-080-PP-W	Type 4 'T' shaped safety light curtain with 3 beams	957201761
SE4-L2-050-PP-W	Type 4 'L' shaped safety light curtain with 2 beams	957201771
SE4-L3-080-PP-W	Type 4 'L' shaped safety light curtain with 3 beams	957201781
SE4-S2-050-PP-W	Type 4 linear safety light curtain with 2 beams	957201791
SE4-S3-080-PP-W	Type 4 linear safety light curtain with 3 beams	957201801

## ACCESSORY SELECTION AND ORDER INFORMATION

MODEL	DESCRIPTION	ORDER N°
SE-SRT	Muting connection box	95ASE1001

*Please refer also to **Safety Device Accessories***

**Note:** all accessories have to be ordered separately

**Distributed by:**

Datasensor SpA endeavours to continuously improve and renew its products; for this reason the technical data and contents of this catalogue may undergo variations without prior notice. For correct installation and use Datasensor SpA can guarantee only the data indicated in the instruction manual supplied with the products.

Printed in Italy in March 2006  
Rev. 02

# SAFETY DEVICES